

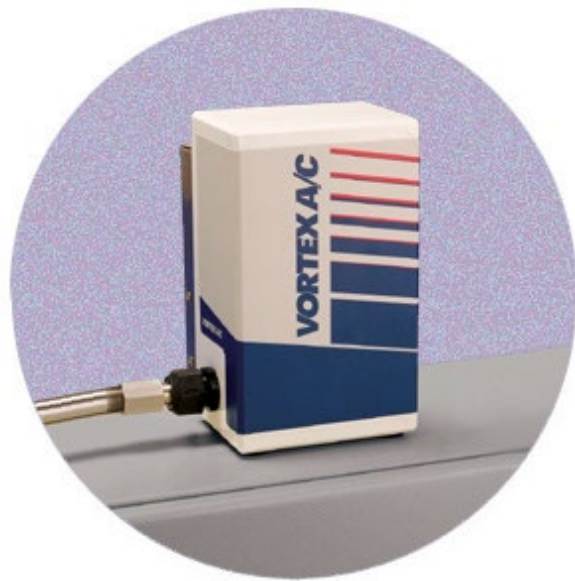

# Vortex Cabinet Cooler Systems



IOM Manual

This page intentionally left blank



## **Copyright Notice:**

This document contains information proprietary to Purge Solutions, Inc. with all rights reserved worldwide. Any reproduction or disclosure of this publication, or any part thereof, to persons other than Purge Solutions, Inc. personnel or customers is strictly prohibited, except by written permission of Purge Solutions, Inc. Unauthorized use, disclosure, reproduction, or translation of this publication will result in Purge Solutions, Inc. exercising maximum possible legal action against all persons and / or organizations involved.

## **Disclaimer:**

Purge Solutions, Inc. makes every effort to ensure the accuracy and completeness of this manual. However, we cannot be responsible for errors, omissions, or any loss of data as the results of errors or omissions. We therefore make no representations or warranties with respect to the contents hereof. Further, Purge Solutions, Inc. reserves the right to revise this publication and to make changes in the content hereof, without obligation to notify any person or organization of such revision or changes.

## **Shipment Arrival Procedures:**

This shipment has been thoroughly inspected at the factory prior to its delivery to the carrier. After the shipment is picked up by the carrier, it becomes their responsibility. When the shipment arrives, make certain that it is undamaged and complete.

## **Patent Notice:**

Manufactured under United States, Worldwide Patents, and Patents Pending.

## **Trademark Information:**

Purge Solutions, Inc. and its logo(s) are trademark(s) of Purge Solutions, Inc.

---

# Table of Contents

---

Legal Notices and Revision History Inside  
front cover

## Section 1

How To Use This Manual	1
Safety Considerations	1
Label Definition Table	2
Locating Information	2
General Safety	3
General Precautions	3
Electrical Power	4
System Location	4

## Section 2

Specifications	5
Certifications	5
Environmental	
Conditions	5
Features	5
Model Number Matrix	6
Sizing Air Line	7

## Section 3

Introduction	8
--------------	---

## Section 4

Installation	9
--------------	---

## Section 5

Drawings	12
Model PSO-CO0900	13
Model PSO-CO1500	14
Model PSO-CO2500	15
Model PSO-CO5000	16
Model PSO-TC0900	17
Model PSO-TC1500	18
Model PSO-TC2500	19
Model PSO-TC5000	20
Model PSO-SBUV-S	21
Model PSO-SBUV-T	22
Model PSO-MBUV-S	23
Model PSO-MBUV-T	24
Model PSO-LBUV-S	25
Model PSO-LBUV-T	26
Check Valve	27
Cold Air Muffler	28
Side Mount Kit	29

## Section 6

Maintenance and Troubleshooting	30
------------------------------------	----

## Section 7

Getting Help	31
Warranty	32

---



# Section 1

# How to Use This Manual

## Safety Considerations:

This chapter includes important information that must be read and understood by all persons installing, using, or maintaining this equipment. While this manual is designed to aid personnel in the correct and safe installation, operation, and maintenance of the systems described. Personnel must consider all actions and procedures for potential hazards or conditions that may not have been anticipated in the written procedures. If a procedure cannot be performed safely, it must not be performed until appropriate actions can be taken to ensure the safety of equipment and personnel. The procedures in this manual are not designed to replace or supersede required or common sense safety practices. All safety warnings listed in any documents applicable to equipment and parts used in or with the system described in this manual must be read and heeded before commencing work on any part of the system.



***NOTE: Refer to all Hazardous Area Certificates for any Special Conditions of Use. If the sign "X" is placed after the certificate number, it indicates that the equipment or protective system is subject to special conditions for safe use specified in the schedule of the certificate.***



***NOTE: Review all material and safety information in this manual and install in accordance with this document and all other applicable Hazardous Area Standards.***





***WARNING: Failure to follow appropriate safety procedures or inappropriate use of the equipment described in this manual can lead to injury of personnel or equipment damage.***



***WARNING – EXPLOSION HAZARD – Do not disconnect equipment unless power has been removed or the area is known to be non-hazardous.***

---

The following symbols are used throughout this manual to alert users to potential hazards or important information. ***Failure to heed the warnings and cautions listed herein can lead to injury and equipment damage.***

<b>Document Label Definitions Used To Indicate Potential Hazards</b>		
<b>Symbol</b>	<b>Label</b>	<b>Description</b>
	<b>WARNING:</b>	Consists of conditions, practices or procedures that must be observed to prevent personal injury and / or equipment damage.
	<b>CAUTION:</b>	Risk of electric shock or high temperature parts may result in injury if proper precautions are not taken.
	<b>NOTE:</b>	Emphasizes important or essential information.

## Locating Information:



***NOTE:*** *In the interest of completeness, manuals and drawings included with the system may provide information pertaining to options not included with your equipment. Information in application notes supersedes general information in these documents. Information can be located in this manual using any of the following aids.*

1. Table of Contents
2. Getting Help



## General Safety and Operating Information:

This section contains general safety and operating information applicable to equipment installed within hazardous locations. This information must be understood by all persons installing, using, or maintaining the electrical equipment. This information is designed to aid personnel in safe installation, operation, and maintenance of the Vortex Cabinet Cooler Systems. It is not designed to replace or limit appropriate safety measures applicable to work performed by personnel. Any additional safety and operating measures that are required must be determined by and followed by personnel performing work on the electrical equipment.



**WARNING:** *Deviation from the specified instruction or procedure steps can result in injury to personnel, equipment malfunction and / or equipment damage.*



**WARNING:** *Return unit to factory for any repairs or replacement of parts, customer not permitted. This will void all warranties and hazardous location certification(s).*

## General Precautions:

Protective eyewear (*glasses with side shields or goggles as appropriate*) must be worn when servicing. Hot components should be allowed to cool before servicing if possible. Other appropriate equipment or clothing must be used as required by the type of work performed. All applicable regulations and procedures must be followed for the work performed. **Before** beginning any work on the equipment, carefully consider all the potential hazards and ensure that appropriate measures are taken to prevent injury to personnel or equipment damage.



**CAUTION:** *Avoid direct contact with compressed air and do not direct compressed air at any person.*



**CAUTION:** *Applicable permits must be obtained and appropriate precautions must be taken to prevent possible injury to personnel or equipment damage when installing or maintaining this equipment.*

---

## **Electrical Power:**

Vortex Cabinet Cooler Systems offered by Purge Solutions, Inc. are all pneumatic and as such do not require any electrical power for operation. However, appropriate modifications have been made to the Vortex Cabinet Cooler Systems to prevent sparks that may ignite combustible materials that may be present in the Vortex Cabinet Cooler System enclosure environment, which could come from the electrical equipment mounted inside the Vortex Cabinet Cooler System enclosure.

## **System Location:**

The Vortex Cabinet Cooler System must not be installed in an area classification for which it is not rated and must be protected from temperature extremes and potentially high vibration. Do not install where compressed air being exhausted will be directed at personnel passing enclosure Vortex Cabinet Cooler System is mounted.

---



## Section 2

# Specifications

### Certifications

***Built to be Certified for Installation and Use in Gas and Dust Hazardous Locations***

Class I, Division 1 or 2, Class II, Division 1 or 2 and Class III  
ATEX and IECEx Zone 1 or 2

### Environmental & Utility Conditions

Operating Temperature Range	- 40°F to 170°F (- 40°C to 77°C)
Storage Temperature Range	- 58°F to 189°F (- 50°C to 87°C)
Used	For Indoor and Outdoor Use
Ingress Protection	NEMA4X and IP66
Optimal Compressed Air Pressure	100 psig (6.9 bar)
Maximum Compressed Air Pressure	150 psig (10.3 bar)
Maximum Compressed Air Line Temperature	110°F (43°C)
Compressed Air Supply Quality	Water and oil-free, - 40°F (- 40°C) dew point, particles ≤ 5μ, ISA grade hydrocarbon free

### Features

Thermostat in Thermostat Vortex Cabinet Coolers are mechanical, which maintains temperatures in enclosure between 80°F to 90°F (27°C to 32°C)
Supplied with check valve, cold air muffler and air ducting kit
No electrical wiring required
Maintains above atmospheric pressure in enclosure, which can be used as protective gas supply for purge / pressurized applications

---

**Continuous Operation Vortex Cabinet  
Cooler System (*Without Thermostat  
Control*) Model Number Matrix**

<b>Cooling Capacity</b>	<b>Air Consumption @ 100 psig (6.9 bar)</b>	<b>Model Number</b>
900 Btu / Hr (264 W)	15 SCFM (425 LPM)	PSO-CO0900
1500 Btu / Hr (440 W)	25 SCFM (708 LPM)	PSO-CO1500
2500 Btu / Hr (732 W)	35 SCFM (991 LPM)	PSO-CO2500
5000 Btu / Hr (1465 W)	70 SCFM (1981 LPM)	PSO-CO5000

**Thermostat Controlled Vortex Cabinet  
Cooler System Model Number Matrix**

<b>Cooling Capacity</b>	<b>Air Consumption @ 100 psig (6.9 bar)</b>	<b>Model Number</b>
900 Btu / Hr (264 W)	15 SCFM (425 LPM)	PSO-TC0900
1500 Btu / Hr (440 W)	25 SCFM (708 LPM)	PSO-TC1500
2500 Btu / Hr (732 W)	35 SCFM (991 LPM)	PSO-TC2500
5000 Btu / Hr (1465 W)	70 SCFM (1981 LPM)	PSO-TC5000

---

## Sizing Compressed Air Supply Line

Calculate total compressed air consumption in SCFM (SLPM)

Determine required length of compressed air line for connecting to main supply

Locate pipe length in far left column of table below

Locate pipe size at top column of table below

**Maximum Airflow SCFM through pipe at 5 psig Pressure Drop @ 100 psig & 70°F**

Pipe Length in Feet	Pipe Size in Schedule 40								
	1/4	3/8	1/2	3/4	1	1-1/4	1-1/2	2	2-1/2
10	29	65	120	254	480	978	1483	2863	4536
20	21	46	85	180	340	692	1049	2024	3208
30	17	37	70	147	277	565	856	1653	2619
40	15	32	60	127	240	489	792	1431	2268
50	13	29	54	114	215	437	663	1280	2029
60	12	26	49	104	196	399	606	1169	1852
70	11	25	46	96	181	370	561	1082	1715
80	10	23	43	90	170	346	524	1012	1604
90	10	22	40	85	160	326	494	954	1512
100	9	21	38	80	152	309	469	905	1435

**Maximum Airflow SCFM through pipe at 5 psig Pressure Drop @ 6.9 bar & 21°C**

Pipe Length in Meters	Pipe Size in Schedule 40								
	1/4	3/8	1/2	3/4	1	1-1/4	1-1/2	2	2-1/2
3	821	1840	3396	7188	13584	27677	42117	81023	128369
6	594	1302	2406	5094	9622	19584	29687	57279	90786
9	481	1047	1981	4160	7839	15990	24225	46780	74188
12	425	906	1698	3594	6732	13839	20999	40497	64184
15	368	821	1528	3226	6085	12367	18763	36224	57421
18	340	736	1387	2943	5547	11292	17150	33083	52412
21	311	708	1302	2717	5122	10471	15877	30621	48535
24	283	651	1217	2547	4811	9792	14829	28640	45393
27	269	623	1132	2406	4528	9226	13980	26998	42790
31	255	594	1075	2264	4302	8745	13273	25612	40611

Hose Maximum Airflow: 1/2 inch I.D Hose = 3/8 inch Pipe

Hose Maximum Airflow: 3/4 inch I.D Hose = 1/2 inch Pipe

## Section 3

# Introduction

A Vortex Cabinet Cooler System is designed to use dry clean compressed air, refer to Compressed Air Supply Quality, page 6 under Environmental and Utility Conditions, to cool industrial enclosures without the use of refrigerants. A Vortex tube mounted on the outside of the enclosure lowers the temperature and pressure of the compressed air supplied into the enclosure.

How it works is the Vortex tube cylindrical shape causes the input compressed air to rotate and as it is forced down the inner walls of the Vortex tube. The faster moving portion of the air exits as hot air exhaust located on the outside of the enclosure. The remaining slower moving air exits through the cold air-port into the enclosure.

---

## Section 4

# Installation



**WARNING:** Before attempting to install any Vortex Cabinet Cooler System; review all the material and all safety information in this manual and all other applicable documents.



**WARNING:** Applicable permits must be obtained and appropriate precautions must be taken to prevent possible injury to personnel or equipment damage when installing any Vortex Cabinet Cooler System.



**NOTE:** Refer to all Hazardous Area Certificates for any Special Conditions of Use. If the sign “X” is placed after the certificate number, it indicates that the equipment or protective system is subject to special conditions for safe use specified in the schedule of the certificate.



**NOTE:** Review all material and safety information in this manual and install in accordance with this document and all other applicable Hazardous Area Standards.



**NOTE:** Purge Solutions, Inc. is NOT responsible for any misuse or improper installation of product, assumes no liability for special or consequential damages caused by use or misuse or improper installation of its products sold and assumes no liability for injury from use or misuse or improper installation of its products or attached products.



**WARNING:** Failure to heed the following information may lead to injury of personnel or equipment damage.



**NOTE:** There are special modifications and sizing requirements to be made before Vortex Cabinet Coolers are able to be installed and used in a hazardous area.

---



---

## Installation:

Review all of the material in this manual prior to installing any Vortex Cabinet Cooler System. If you have any questions, please contact your local Purge Solutions, Inc. representative or the factory (Refer to Getting Help, page 30). To maintain the proper ingress protection the Vortex Cabinet Coolers must be installed as follows:

Continuous Operation Vortex Cabinet Coolers can be installed in a vertical and upright orientation on a flat horizontal surface at the top of the enclosure. If the application requires the Continuous Operation Vortex Cabinet Cooler to be side mounted on the enclosure, Purge Solutions, Inc. offers a Side Mount Kit that can be mounted on a vertical flat surface on the side or back of enclosure, refer to Page 12.

Thermostat Controlled Vortex Cabinet Coolers can be either top horizontal flat surface or side vertical flat surface mounted on the enclosure. If side mounted on enclosure; the compressed air inlet fitting must be pointing upward or with stainless steel shroud facing downward to the floor when mounted on a vertical flat surface on the side or back of enclosure, refer to Page 12.

Exhaust Vents supplied with Vortex Cabinet Coolers must also be installed in a vertical upright position, depending on Side or Top mount Exhaust Vent, either on a horizontal flat surface on top of enclosure or vertical flat surface on the side or back of the enclosure.

The following instructions are for installation of Vortex Cabinet Cooler Systems not in combination with Purge Solutions, Inc. Purge / Pressurization Systems. For help selecting the proper Vortex Cabinet Cooler System and Purge Solutions, Inc. Purge / Pressurization System combination, please contact your local Purge Solutions, Inc. representative or the factory (Refer to Getting Help, page 30).

**Step 1:** Make sure the area surrounding the enclosure that the Vortex Cabinet Cooler System will be installed is known to be non-hazardous.

**Step 2:** Make sure all power is disconnected from the electrical equipment located in the enclosure that the Vortex Cabinet Cooler System will be installed.

**Step 3:** Choose a mounting location for the Vortex Cabinet Cooler System on the enclosure in a location for proper hot air exhausting from Vortex Cabinet Cooler and exhausting from inside enclosure.

**Step 4:** Drill or punch one each 1.94 (49.0) diameter hole “1-1/2 knockout size” for model numbers PSO-CO0900, PSO-CO1500, PSO-CO2500, PSO-TC0900, PSO-TC-1500 and PSO-TC2500. Drill or punch two each 1.94 (49.0) diameter holes “1-1/2 knockout size” for model numbers PSO-CO5000 and PSO-TC5000. Refer to drawings in Section 5 for center to center distance of two holes.

---

**Step 5:** Insert Vortex Cabinet Cooler into hole(s) and secure with locknut provided.

**Step 6:** Attach the check valve(s) to the outlet of the Vortex Cabinet Cooler.

**Step 7:** If needed attached the cold air muffler(s) to the outlet of the check valve(s).

**Step 8:** If needed perforate the ducting tube with several 0.13 (3.3) diameter holes and secure to interior of enclosure.

**Step 9:** Attach the ducting tubing to the cold air muffler(s).

**Step 10:** Connect compressed air supply to the Vortex Cabinet Cooler.

**Step 11:** Drill or punch a 0.57 (14.5) diameter hole for the Small Back-Up Vent, a 1.31 (33.3) diameter hole for the Medium Back-Up Vent and a 2.38 (60.5) diameter hole for the Large Back-Up Vent.

**Step 12:** Insert Back-Up Vent into hole and secure with locknut provided.

**Step 13:** Vortex Cabinet Cooler System is now ready to use.

---

---

## Section 5

# Drawings

Page 13: Model PSO-CO0900 = Continuous Operation 900 BTU per Hour Vortex Cabinet Cooler System

Page 14: Model PSO-CO1500 = Continuous Operation 1500 BTU per Hour Vortex Cabinet Cooler System

Page 15: Model PSO-CO2500 = Continuous Operation 2500 BTU per Hour Vortex Cabinet Cooler System

Page 16: Model PSO-CO5000 = Continuous Operation 5000 BTU per Hour Vortex Cabinet Cooler System

Page 17: Model PSO-TC0900 = Thermostat Controlled 900 BTU per Hour Vortex Cabinet Cooler System

Page 18: Model PSO-TC1500 = Thermostat Controlled 1500 BTU per Hour Vortex Cabinet Cooler System

Page 19: Model PSO-TC2500 = Thermostat Controlled 2500 BTU per Hour Vortex Cabinet Cooler System

Page 20: Model PSO-TC5000 = Thermostat Controlled 5000 BTU per Hour Vortex Cabinet Cooler System

Page 21: Model PSO-SBUV-S = Small Side Mount Back-Up Vent

Page 22: Model PSO-SBUV-T = Small Top Mount Back-Up Vent

Page 23: Model PSO-MBUV-S = Medium Side Mount Back-Up Vent

Page 24: Model PSO-MBUV-T = Medium Top Mount Back-Up Vent

Page 25: Model PSO-LBUV-S = Large Side Mount Back-Up Vent

Page 26: Model PSO-LBUV-T = Large Top Mount Back-Up Vent

Page 27: Check Valve

Page 28: Cold Air Muffler

Page 29: Continuous Operation Vortex Cooler Side Mount Kit

---

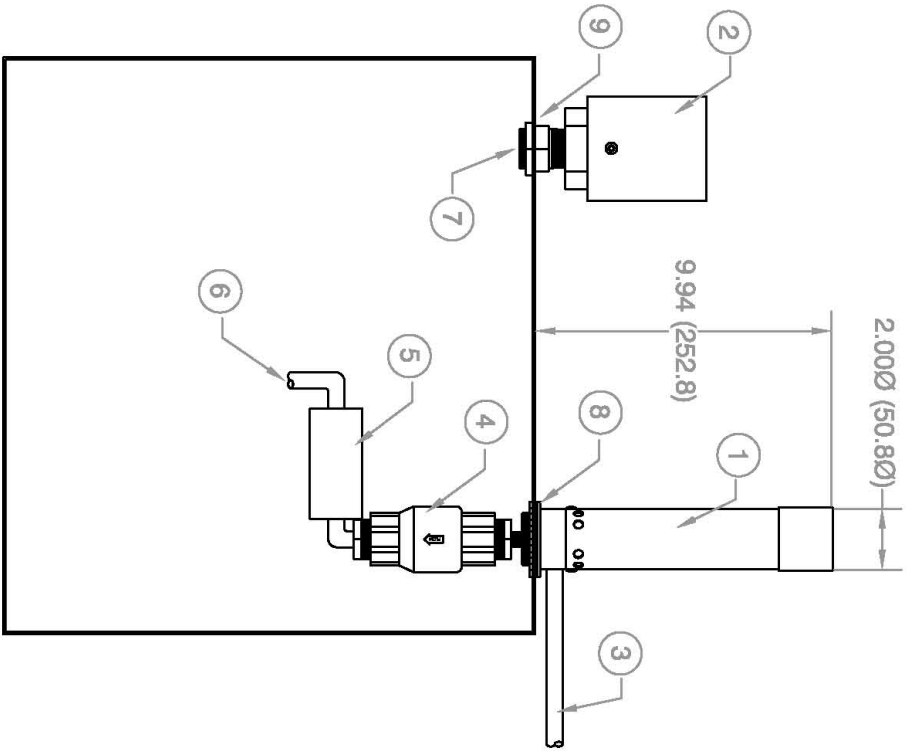

**NOTES:**

1. MODIFIED VORTEX CABINET COOLER FOR HAZARDOUS AREA INSTALLATION AND USE.
2. SMALL ENCLOSURE EXHAUST VENT WITH REQUIRED SPARK ARRESTOR.
3. COMPRESSOR AIR SUPPLY TO VORTEX CABINET COOLER = 1/4 FNPT.
4. CHECK VALVE.
5. COLD AIR MUFFLER "OPTION TO USE".
6. VORTEX CABINET COOLER COLD AIR DUCT TUBING INTO ENCLOSURE.
7. VORTEX CABINET COOLER COLD AIR EXHAUSTED FROM ENCLOSURE.
8. REQUIRED HOLE SIZE FOR VORTEX CABINET COOLER = 1.940 (49.00)
9. REQUIRED HOLE SIZE FOR EXHAUST VENT WITH SPARK ARRESTOR = 0.570 (14.50)

REV #	ECO #	CHANGE(S) DESCRIPTION		DATE	CHANGE BY	APPD BY
<p>The contents of this drawing is the sole property of Purge Solutions. This print and/or its contents shall not be traced or reproduced without prior written permission from Purge Solutions. It shall not be used directly or indirectly in any way detrimental to the interest of Purge Solutions.</p>						
<p><b>DO NOT SCALE DRAWING.</b>          UNLESS OTHERWISE SPECIFIED,          Dimensions are in inches          Dimensions in ( ) are in mm          Tolerances: X = ± 0.015          YXX = ± 0.010          ZXX = ± 0.020          Angles = 20.0°          Break All Sharp Edges          33 Minimum Sample As Weld</p>						
DRAWN: WJT		TITLE: PSO-C00900 CONTINUOUS OPERATION		SHEET 1 OF 1		
DATE: 11/MAY/11		PART & DWG #: PSO-C00900		MATERIAL: NOTED		
CHECKED: WJT		DATE: 11/MAY/11		SCALE: N/A		
APPROVED: WJT		DATE: 11/MAY/11		FINISH: N/A		
<p>DATE</p>				<p>CHANGE BY</p>		
<p>DATE</p>				<p>APPD BY</p>		
<p>WEBSTER, TEXAS, USA 832-388-7189</p>						

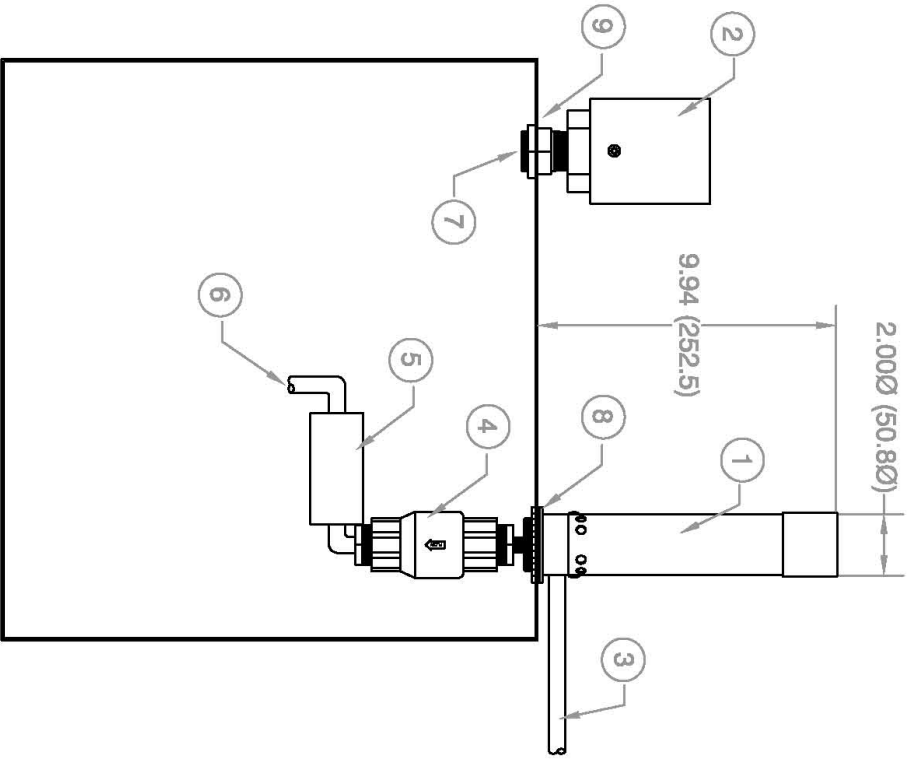

- NOTES:**
1. MODIFIED VORTEX CABINET COOLER FOR HAZARDOUS AREA INSTALLATION AND USE.
  2. MEDIUM ENCLOSURE EXHAUST VENT WITH REQUIRED SPARK ARRESTOR.
  3. COMPRESSOR AIR SUPPLY TO VORTEX CABINET COOLER = 1/4 FNPT.
  4. CHECK VALVE.
  5. COLD AIR MUFFLER "OPTION TO USE".
  6. VORTEX CABINET COOLER COLD AIR DUCT TUBING INTO ENCLOSURE.
  7. VORTEX CABINET COOLER COLD AIR EXHAUSTED FROM ENCLOSURE.
  8. REQUIRED VORTEX CABINET COOLER HOLE SIZE = 1.94Ø (49.0Ø)
  9. REQUIRED EXHAUST VENT WITH SPARK ARRESTOR HOLE SIZE = 1.31Ø (33.3Ø)

REV #	ECO #	CHANGE(S) DESCRIPTION		DATE	CHANGE BY	APPD BY
<p>The contents of this drawing is the sole property of Purge Solutions. This print and/or its contents shall not be traced or reproduced without prior written permission from Purge Solutions. It shall not be used directly or indirectly in any way detrimental to the interest of Purge Solutions.</p> <p><b>DO NOT SCALE DRAWING.</b> UNLESS OTHERWISE SPECIFIED: Dimension in inches Dimension in Ø/in in mm Tolerances: X = ± 0.015                   XX = ± 0.010                   XXX = ± 0.008 Angular = 2015° Break All Sharp Edges SS Minimum Except As Noted</p>						
DRAWN: WJT		TITLE: PSO-C01500 CONTINUOUS OPERATION VORTEX CABINET COOLER SYSTEM		SHEET 1 OF 1		
DATE: 11/MAY/11		PART & DWG #: PSO-C01500		MATERIAL: NOTED		
CHECKED: WJT		DATE: 11/MAY/11		SCALE: N/A		
APPROVED: WJT		DATE: 11/MAY/11		FINISH: N/A		
<p>WEBSTER, TEXAS, USA 832-388-7186</p>						

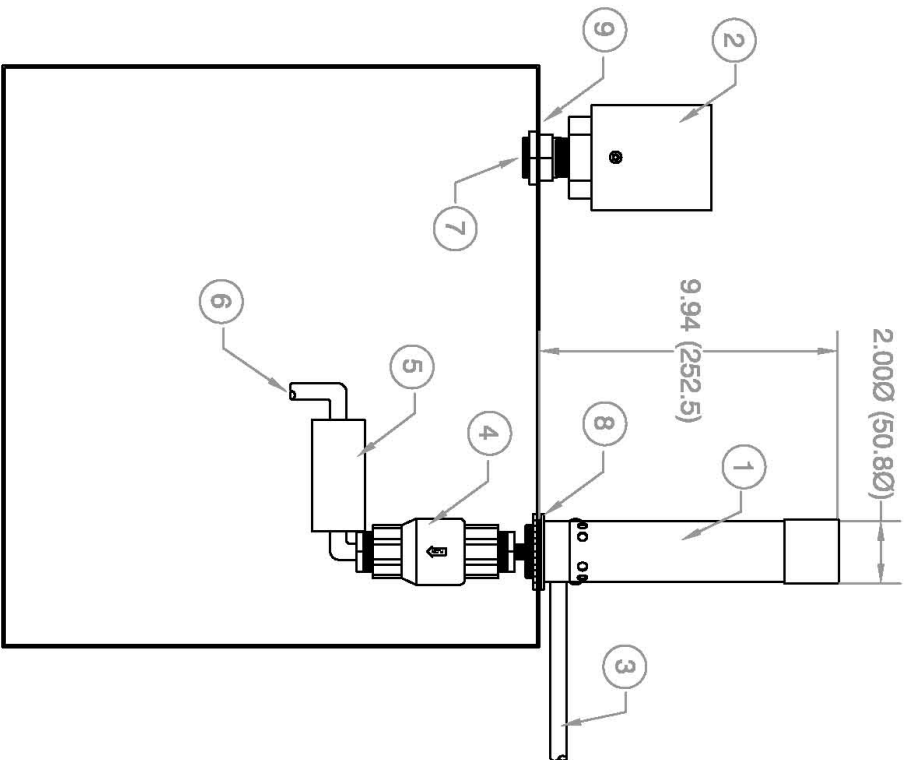

**NOTES:**

1. MODIFIED VORTEX CABINET COOLER FOR HAZARDOUS AREA INSTALLATION AND USE.
2. MEDIUM ENCLOSURE EXHAUST VENT WITH REQUIRED SPARK ARRESTOR.
3. COMPRESSOR AIR SUPPLY TO VORTEX CABINET COOLER = 1/4 FNPT.
4. CHECK VALVE.
5. COLD AIR MUFFLER "OPTION TO USE".
6. VORTEX CABINET COOLER COLD AIR DUCT TUBING INTO ENCLOSURE.
7. VORTEX CABINET COOLER COLD AIR EXHAUSTED FROM ENCLOSURE.
8. REQUIRED VORTEX CABINET COOLER HOLE SIZE = 1.94Ø (49.0Ø)
9. REQUIRED EXHAUST VENT WITH SPARK ARRESTER HOLE SIZE = 1.31Ø (33.3Ø)

REV #	ECO #	CHANGE(S) DESCRIPTION	DATE	CHANGE BY	APPD BY
<p><b>DO NOT SCALE DRAWING.</b>  <b>UNLESS OTHERWISE SPECIFIED-</b>            Dimensions Are in Inches            Dimensions in 0.1mm in mm            Tolerances: X = ± 0.015                              XX = ± 0.010                              XXX = ± 0.005            Angles - 2x15°            Break All Sharp Edges            68 Minimum Except as Noted</p>					
DRAWN: WJT DATE: 11/MAY/11		TITLE: PSO-CO2500 CONTINUOUS OPERATION VORTEX CABINET COOLER SYSTEM			
CHECKED: WJT DATE: 11/MAY/11		PART & DWG #: PSO-CO2500		MATERIAL: NOTED	
APPROVED: WJT DATE: 11/MAY/11		SHEET 1 OF 1 SCALE: N/A      DWG SIZE: A		FINISH: N/A	
			WEBSTER, TEXAS, USA 832-388-7196		

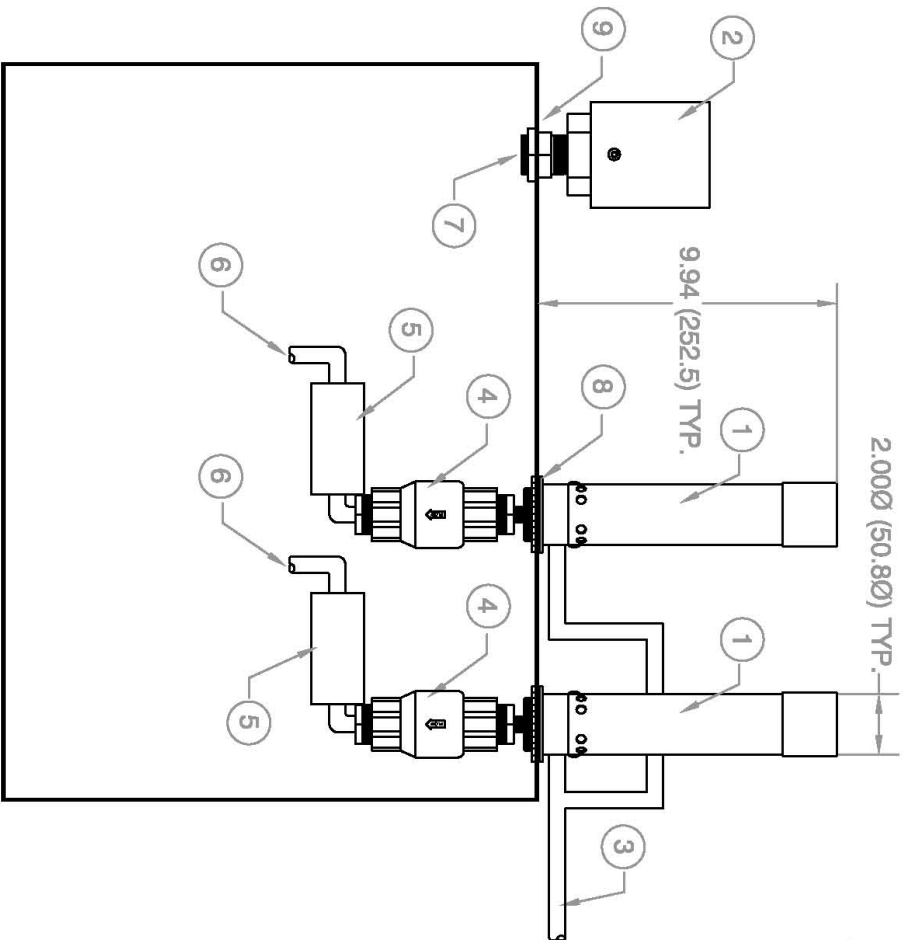

**NOTES:**

1. 2 EACH MODIFIED VORTEX CABINET COOLERS FOR HAZARDOUS AREA INSTALLATION AND USE.
2. LARGE ENCLOSURE EXHAUST VENT WITH REQUIRED SPARK ARRESTOR.
3. COMPRESSOR AIR SUPPLY TO VORTEX CABINET COOLER = 2 EACH 1/4 FNPT.
4. 2 EACH CHECK VALVES.
5. 2 EACH COLD AIR MUFFLERS "OPTION TO USE".
6. 2 EACH VORTEX CABINET COOLERS COLD AIR DUCT TUBING INTO ENCLOSURE.
7. VORTEX CABINET COOLER COLD AIR EXHAUSTED FROM ENCLOSURE.
8. 2 EACH REQUIRED VORTEX CABINET COOLER HOLE SIZE = 1.94Ø (49.0Ø)
9. REQUIRED EXHAUST VENT WITH SPARK ARRESTOR HOLE SIZE = 2.38Ø (60.5Ø)

REV #	ECO #	CHANGE(S) DESCRIPTION	DATE	CHANGE BY	APPD BY
CHANGE(S) DESCRIPTION					
<p><b>DO NOT SCALE DRAWING.</b> UNLESS OTHERWISE SPECIFIED: Dimension in ( ) are in mm Tolerances: X = ± 0.015                   XX = ± 0.030                   XXX = ± 0.050 Angular = 2015° Break All Sharp Edges CS Minimum Except As Noted</p>		<p><b>TITLE:</b> PSO-CO2500 CONTINUOUS OPERATION VORTEX CABINET COOLER SYSTEM</p>		<p><b>MATERIAL:</b> NOTED</p>	
<p><b>DRAWN:</b> WJT <b>DATE:</b> 11/MAY/11</p>		<p><b>PART &amp; DWG #:</b> PSO-CO2500</p>		<p><b>FINISH:</b> N/A</p>	
<p><b>CHECKED:</b> WJT <b>DATE:</b> 11/MAY/11</p>		<p><b>SHEET</b> 1 <b>OF</b> 1</p>		<p><b>SCALE:</b> N/A</p>	
<p><b>APPROVED:</b> WJT <b>DATE:</b> 11/MAY/11</p>		<p><b>DWG SIZE</b> A</p>		<p><b>DATE</b></p>	
<p>The contents of this drawing is the sole property of Purge Solutions. This print and/or its contents shall not be traced or reproduced without prior written permission from Purge Solutions. It shall not be used directly or indirectly in any way detrimental to the interest of Purge Solutions.</p>					

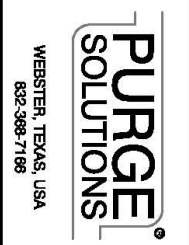

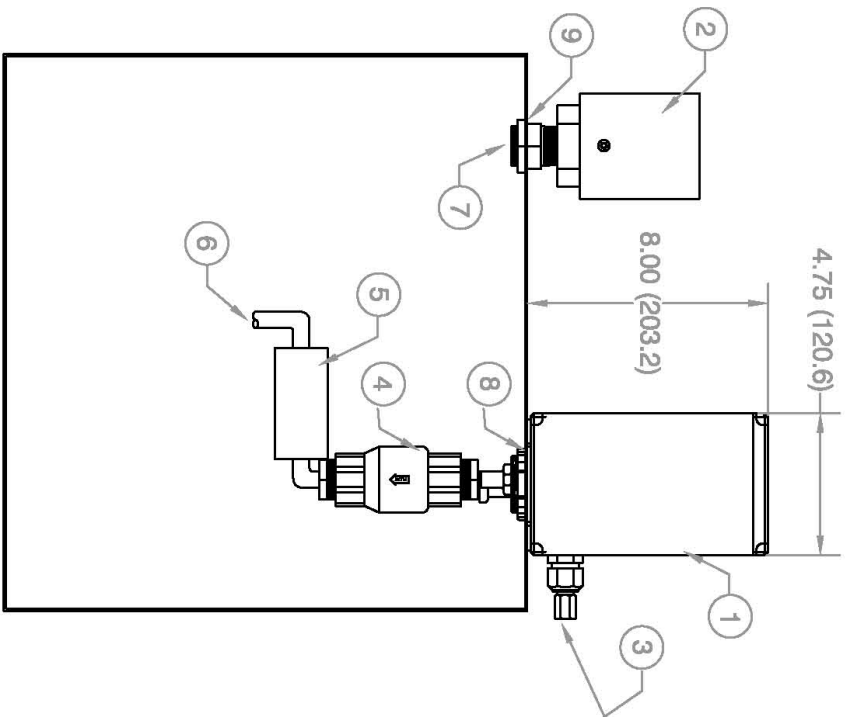

**NOTES:**

1. MODIFIED VORTEX CABINET COOLER WITH MECHANICAL THERMOSTAT FOR HAZARDOUS AREA INSTALLATION AND USE.
2. SMALL ENCLOSURE EXHAUST VENT WITH REQUIRED SPARK ARRESTOR.
3. COMPRESSED AIR SUPPLY TO VORTEX CABINET COOLER 3/8 - 18 FNPT FITTING.
4. CHECK VALVE.
5. COLD AIR MUFFLER "OPTION TO USE".
6. VORTEX CABINET COOLER COLD AIR DUCT TUBING INTO ENCLOSURE.
7. VORTEX CABINET COOLER COLD AIR EXHAUSTED FROM ENCLOSURE.
8. REQUIRED HOLE SIZE FOR VORTEX CABINET COOLER = 1.94Ø (49.0Ø)
9. REQUIRED HOLE SIZE FOR EXHAUST VENT WITH SPARK ARRESTOR = 0.57Ø (14.5Ø)

REV #	ECO #	CHANGE(S) DESCRIPTION	DATE	CHANGE BY	APPD BY
<p>The contents of this drawing is the sole property of Purge Solutions. This print and/or its contents shall not be traced or reproduced without prior written permission from Purge Solutions. It shall not be used directly or indirectly in any way detrimental to the interest of Purge Solutions.</p>					
<p><b>DO NOT SCALE DRAWING.</b>            UNLESS OTHERWISE SPECIFIED:            Dimensions are in inches            Dimension in ( ) are in mm            Tolerances: X = ± 0.015                              XX = ± 0.010                              XXX = ± 0.008            Angles = ±0.15°            Break All Sharp Edges            CS Minimum Except as Noted</p>					
DRAWN: WJT DATE: 14/DEC/09		TITLE: PSO-TC0900 THERMOSTAT CONTROLLED VORTEX CABINET COOLER SYSTEM		DATE:	
CHECKED: WJT DATE: 14/DEC/09		PART & DWG #: PSO-TC0900		MATERIAL: NOTED	
APPROVED: WJT DATE: 14/DEC/09		SHEET: 1 OF 1		FINISH: N/A	
		SCALE: N/A		DWG SIZE: A	
WEBSTER, TEXAS, USA 832-368-7186					



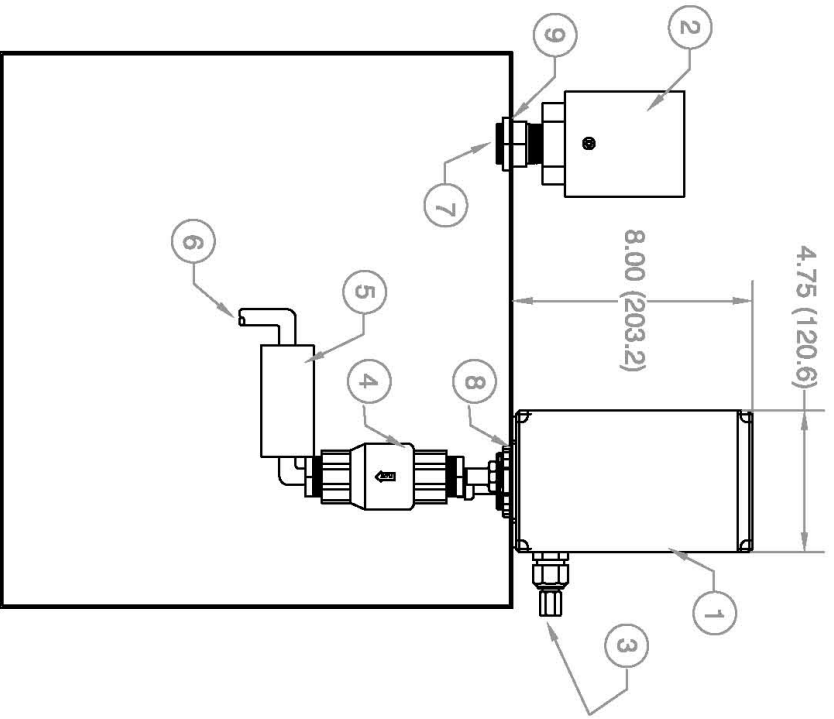

**NOTES:**

1. MODIFIED VORTEX CABINET COOLER WITH MECHANICAL THERMOSTAT FOR HAZARDOUS AREA INSTALLATION AND USE.
2. MEDIUM ENCLOSURE EXHAUST VENT WITH REQUIRED SPARK ARRESTOR.
3. COMPRESSED AIR SUPPLY TO VORTEX CABINET COOLER 3/8 - 18 FNPT FITTING.
4. CHECK VALVE.
5. COLD AIR MUFFLER "OPTION TO USE".
6. VORTEX CABINET COOLER COLD AIR DUCT TUBING INTO ENCLOSURE.
7. VORTEX CABINET COOLER COLD AIR EXHAUSTED FROM ENCLOSURE.
8. REQUIRED HOLE SIZE FOR VORTEX CABINET COOLER = 1.94Ø (49.0Ø)
9. REQUIRED HOLE SIZE FOR EXHAUST VENT WITH SPARK ARRESTOR = 1.31Ø (33.3Ø)

REV #	ECO #	CHANGE(S) DESCRIPTION	DATE	CHANGE BY	APPD BY
<p>The contents of this drawing is the sole property of Purge Solutions. This print and/or its contents shall not be traced or reproduced without prior written permission from Purge Solutions. It shall not be used directly or indirectly in any way detrimental to the interest of Purge Solutions.</p> <p><b>DO NOT SCALE DRAWING.</b> UNLESS OTHERWISE SPECIFIED. Dimension in inches Dimension in ( ) are in mm Tolerance: X = ± 0.015                   XX = ± 0.010                   XXX = ± 0.008 Angle = 1/16" Break All Sharp Edges CS Minimum Corner As Shown</p>					
DRAWN: WJT DATE: 14/DEC/09		TITLE: PSO-TC1500 THERMOSTAT CONTROLLED VORTEX CABINET COOLER SYSTEM			
CHECKED: WJT DATE: 14/DEC/09		PART & DWG #: PSO-TC1500		MATERIAL: NOTED	
APPROVED: WJT DATE: 14/DEC/09		SHEET: 1 OF 1 SCALE: N/A DWG SIZE: A		FINISH: N/A	
			PURGE SOLUTIONS WEBSTER, TEXAS, USA 832-368-7199		

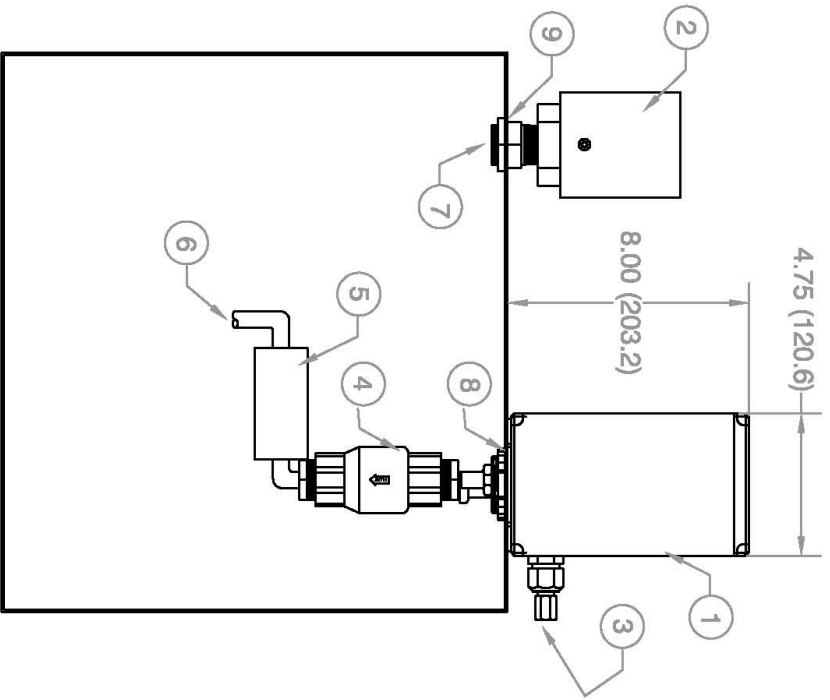

**NOTES:**

1. MODIFIED VORTEX CABINET COOLER WITH MECHANICAL THERMOSTAT FOR HAZARDOUS AREA INSTALLATION AND USE.
2. MEDIUM ENCLOSURE EXHAUST VENT WITH REQUIRED SPARK ARRESTOR.
3. COMPRESSED AIR SUPPLY TO VORTEX CABINET COOLER 3/8 - 18 FNPT FITTING.
4. CHECK VALVE.
5. COLD AIR MUFFLER "OPTION TO USE".
6. VORTEX CABINET COOLER COLD AIR DUCT TUBING INTO ENCLOSURE.
7. VORTEX CABINET COOLER COLD AIR EXHAUSTED FROM ENCLOSURE.
8. REQUIRED HOLE SIZE FOR VORTEX CABINET COOLER = 1.94Ø (49.0Ø)
9. REQUIRED HOLE SIZE FOR EXHAUST VENT WITH SPARK ARRESTOR = 1.31Ø (33.3Ø)

REV #	ECO #	CHANGE(S) DESCRIPTION	DATE	CHANGE BY	APPD BY
<p>The contents of this drawing is the sole property of Purge Solutions. This print and/or its contents shall not be traced or reproduced without prior written permission from Purge Solutions. It shall not be used directly or indirectly in any way detrimental to the interest of Purge Solutions.</p>					
<p><b>DO NOT SCALE DRAWING.</b>          UNLESS OTHERWISE SPECIFIED:          Dimensions Are in Inches          Dimensions in 0.1mm in mm          Tolerances: X = ± 0.015          Y = ± 0.010          Z = ± 0.005          Angular = ±0.15°          Break All Sharp Edges          68 Minimum Except as Noted</p>					
DRAWN: WJT DATE: 14/DEC/09		TITLE: PSO-TC2500 THERMOSTAT CONTROLLED VORTEX CABINET COOLER SYSTEM		SHEET 1 OF 1 SCALE: N/A	
CHECKED: WJT DATE: 14/DEC/09		PART & DWG #: PSO-TC2500		MATERIAL: NOTED	
APPROVED: WJT DATE: 14/DEC/09		DWG SIZE A		FINISH: N/A	
			WEBSTER, TEXAS, USA 832.388.7199		

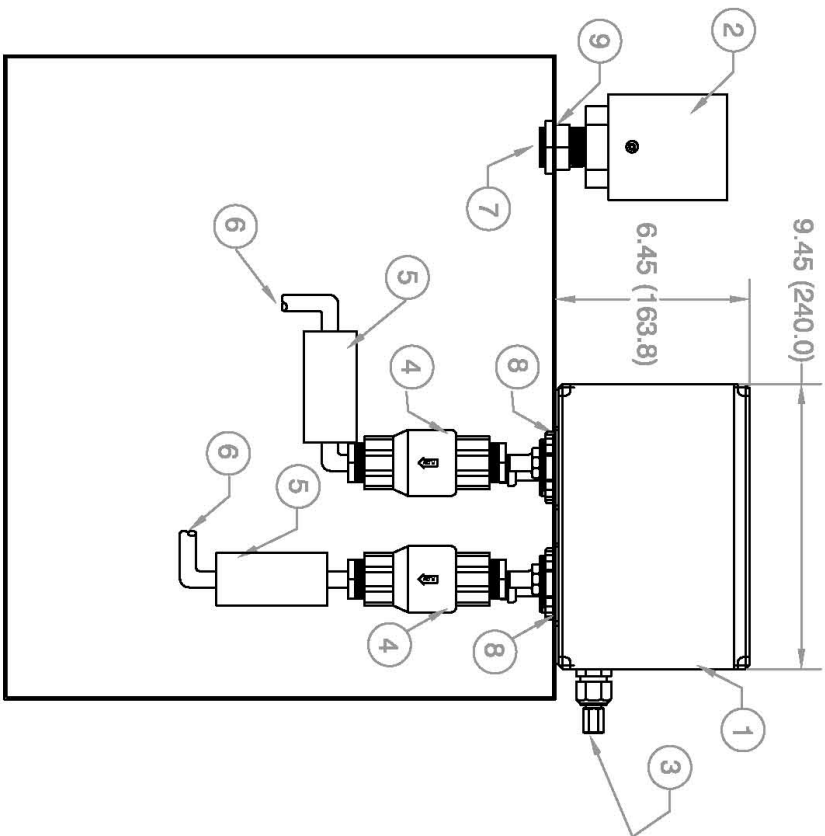

**NOTES:**

1. MODIFIED VORTEX CABINET COOLER WITH MECHANICAL THERMOSTAT FOR HAZARDOUS AREA INSTALLATION AND USE.
2. LARGE ENCLOSURE EXHAUST VENT WITH REQUIRED SPARK ARRESTOR.
3. COMPRESSED AIR SUPPLY TO VORTEX CABINET COOLER 3/8 - 18 FNPT FITTING.
4. 2 EACH CHECK VALVES.
5. 2 EACH COLD AIR MUFFLER "OPTION TO USE".
6. VORTEX CABINET COOLER COLD AIR DUCT TUBING INTO ENCLOSURE.
7. VORTEX CABINET COOLER COLD AIR EXHAUSTED FROM ENCLOSURE.
8. 2 EACH, 4.00 (102.0) APART, REQUIRED HOLE SIZE FOR VORTEX CABINET COOLER = 1.94Ø (49.0Ø)
9. REQUIRED HOLE SIZE FOR EXHAUST VENT WITH SPARK ARRESTOR = 2.38Ø (60.5Ø)

REV #	ECO #	CHANGE(S) DESCRIPTION	DATE	CHANGE BY	APPD BY

<p>The contents of this drawing is the sole property of Purge Solutions. This print and/or its contents shall not be traced or reproduced without prior written permission from Purge Solutions. It shall not be used directly or indirectly in any way detrimental to the interest of Purge Solutions.</p>	<p><b>DO NOT SCALE DRAWING.</b> UNLESS OTHERWISE SPECIFIED: Dimension in inches Dimension in ( ) are in mm Tolerance: X = ± 0.015               XX = ± 0.010               XXX = ± 0.005 Angular = ±0.1° Break All Sharp Edges Ø Minimum Except as Noted</p>	<p>DRAWN: WJT DATE: 14/DEC/09</p>	<p>TITLE: PSO-T05000 THERMOSTAT CONTROLLED VORTEX CABINET COOLER SYSTEM</p>		<p>DATE</p>		
		<p>CHECKED: WJT DATE: 14/DEC/09</p>	<p>PART &amp; DWG #: PSO-T05000</p>	<p>MATERIAL: NOTED</p>		<p>FINISH: N/A</p>	
		<p>APPROVED: WJT DATE: 14/DEC/09</p>	<p>SHEET 1 OF 1</p>	<p>SCALE: N/A</p>			<p>DWG SIZE: A</p>
		<p>SCALE: N/A</p>	<p>DWG SIZE: A</p>	<p>FINISH: N/A</p>			



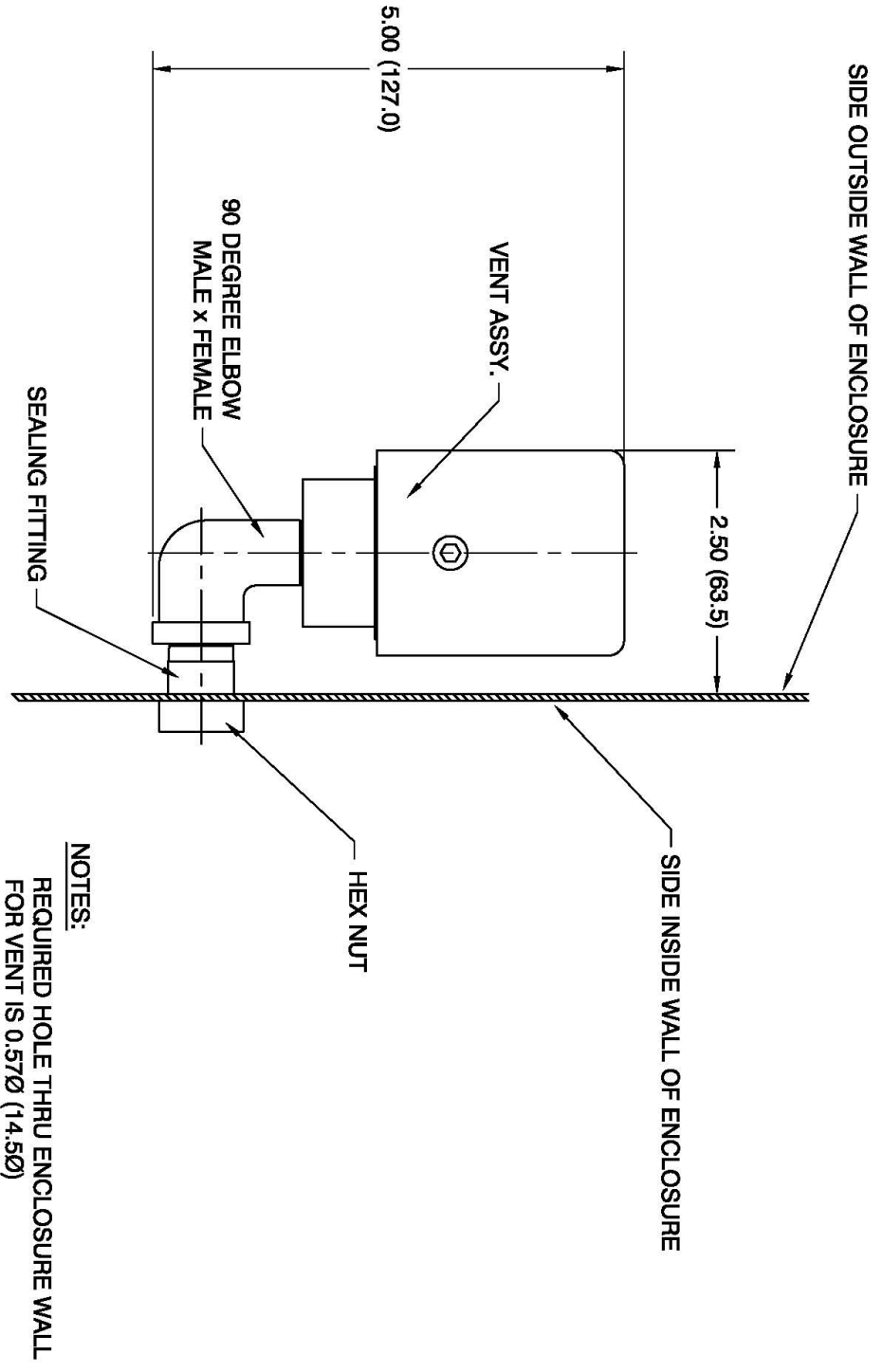

REV #	ECO #	CHANGE(S) DESCRIPTION	DATE	CHANGE BY	APPD BY

<p>The contents of this drawing is the sole property of Purge Solutions. This print and/or its contents shall not be traced or reproduced without prior written permission from Purge Solutions. It shall not be used directly or indirectly in any way detrimental to the interest of Purge Solutions.</p>		<p><b>DO NOT SCALE DRAWING</b> UNLESS OTHERWISE SPECIFIED- Dimensions Are in Inches Dimensions in ( ) Are in mm Tolerances: X = ± 0.015                   XX = ± 0.010                   XXX = ± 0.005 Angles = 24.5° Break All Sharp Edges GB Minimum Export As Made</p>		<p><b>SMALL BACK-UP VENT KIT</b> SIDE MOUNT</p>		<p><b>PURGE SOLUTIONS</b> WEBSTER, TEXAS, USA 832-388-7199</p>
<p>DRAWN: WJT DATE: 02/JAN/04</p>	<p>CHECKED: WJT DATE: 02/JAN/04</p>	<p>PART &amp; DWG #: PSO-SBUV-S</p>	<p>MATERIAL: NOTED</p>	<p>SHEET 1 OF 1</p>		
<p>APPROVED: WJT DATE: 02/JAN/04</p>	<p>SCALE: N/A</p>	<p>DWG SIZE: A</p>	<p>FINISH: N/A</p>	<p>DATE</p>		

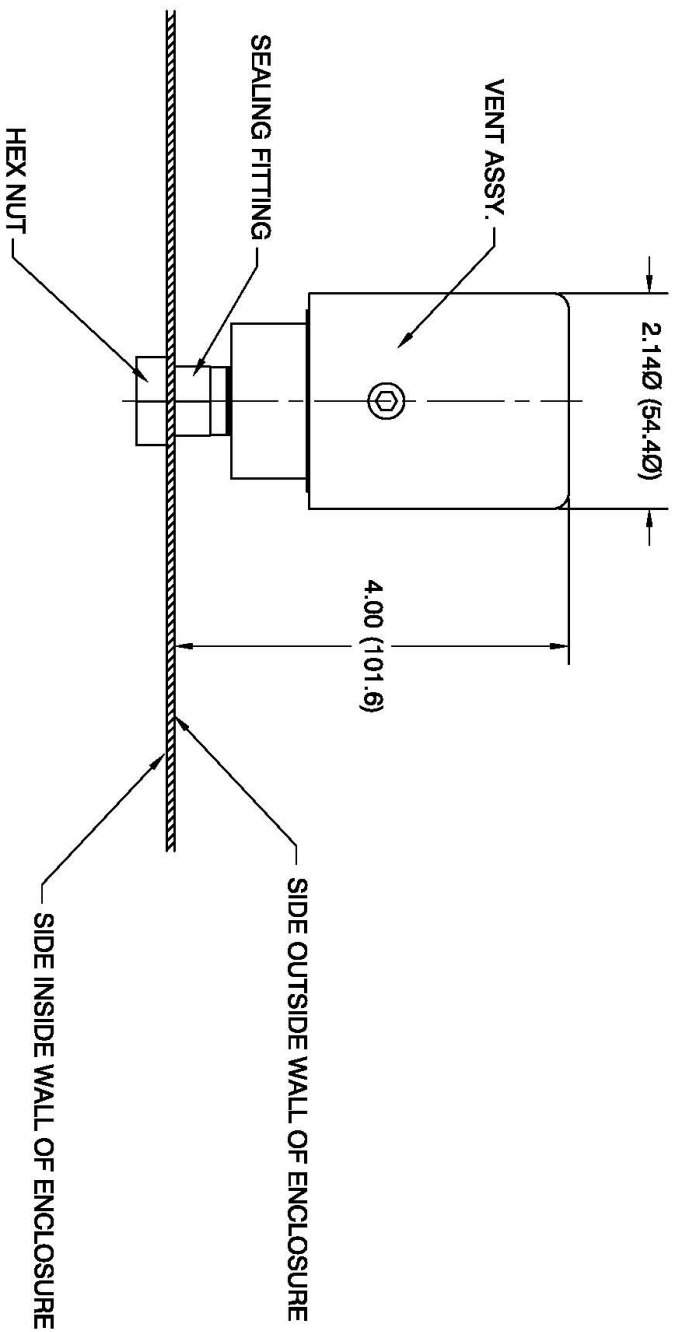

**NOTES:**  
 REQUIRED HOLE THRU ENCLOSURE WALL  
 FOR VENT IS 0.57Ø (14.5Ø)

REV #	ECO #	CHANGE(S) DESCRIPTION		DATE	CHANGE BY	APPD BY
<p>The contents of this drawing is the sole property of Purge Solutions. This print and/or its contents shall not be traced or reproduced without prior written permission from Purge Solutions. It shall not be used directly or indirectly in any way detrimental to the interest of Purge Solutions.</p> <p><b>DO NOT SCALE DRAWING.</b>          UNLESS OTHERWISE SPECIFIED:          Dimension in inches          Dimension in Ø/in in mm          Tolerances: X = ± 0.015          YXX = ± 0.025          Angular = ±0.1°          Break All Sharp Edges          SS Minimum Edge as Noted</p>						
DRAWN: WJT		DATE: 02/JAN/04		TITLE: SMALL BACK-UP VENT KIT		
CHECKED: WJT		DATE: 02/JAN/04		PART & DWG #: PSO-SBUV-T		
APPROVED: WJT		DATE: 02/JAN/04		MATERIAL: NOTED		
SCALE: N/A		SHEET 1 OF 1		FINISH: N/A		
DWG SIZE: A		<p>WEBSTER, TEXAS, USA 832-388-7188</p>				

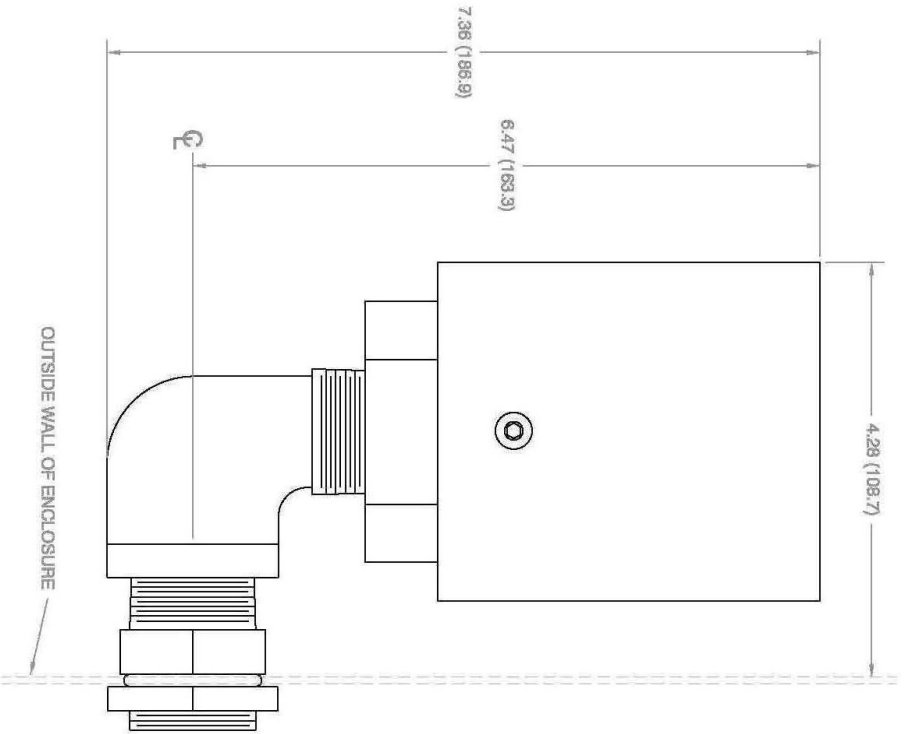

**NOTES:**  
 1. THROUGH HOLE FOR MOUNTING IS 1.310 (33.30).

REV #	ECO #	CHANGE(S) DESCRIPTION	DATE	CHANGE BY	APPD BY

<p>The contents of this drawing is the sole property of Purge Solutions. This print and/or its contents shall not be traced or reproduced without prior written permission from Purge Solutions. It shall not be used directly or indirectly in any way detrimental to the interest of Purge Solutions.</p>		<p><b>DO NOT SCALE DRAWING</b>          UNLESS OTHERWISE SPECIFIED.          Dimensions are in inches          Dimensions in O/A in mm          Tolerances: X = ± 0.015          YZ = ± 0.010          ANGLES = ± 0.5°          Break All Sharp Edges          68 Minimum Edge to Hole</p>		<p><b>DRAWN:</b> SLM  <b>DATE:</b> 11/JUL/08</p> <p><b>CHECKED:</b> SLM  <b>DATE:</b> 11/JUL/08</p> <p><b>APPROVED:</b> SLM  <b>DATE:</b> 11/JUL/08</p>		<p><b>TITLE:</b> MEDIUM BACK-UP VENT          SIDE MOUNT</p> <p><b>PART &amp; DWG #:</b> PSO-MBUV-S</p> <p><b>MATERIAL:</b> N/A</p> <p><b>SHEET:</b> 1 OF 1</p> <p><b>SCALE:</b> N/A <b>DWG SIZE:</b> A</p> <p><b>FINISH:</b> N/A</p>		<p><b>PURGE SOLUTIONS</b>          WEBSTER, TEXAS, USA          832-388-7166</p>	
---	--	--	--	---	--	---	--	--	--

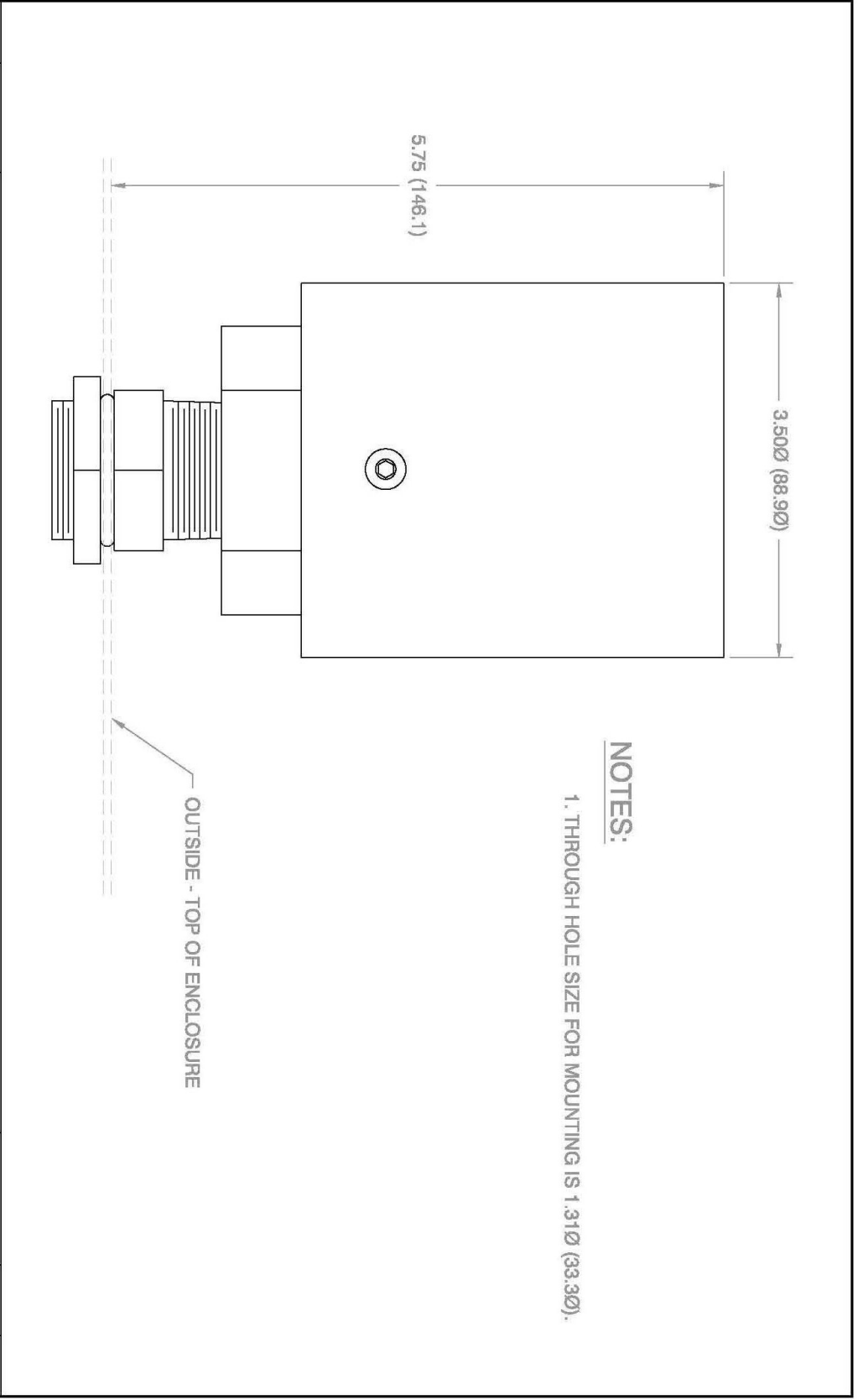

REV #	ECO #	CHANGE(S) DESCRIPTION	DATE	CHANGE BY	APPD BY
<p><b>DO NOT SCALE DRAWING</b> UNLESS OTHERWISE SPECIFIED. Dimensions are in inches Dimensions in ( ) are in mm Tolerances: X = ± 0.015                   XX = ± 0.010                   XXX = ± 0.005 Angular = ±0.5° Break All Sharp Edges 69 Minimum Edge to Hole</p>					
<p>The contents of this drawing is the sole property of Purge Solutions. This print and/or its contents shall not be traced or reproduced without prior written permission from Purge Solutions. It shall not be used directly or indirectly in any way detrimental to the interest of Purge Solutions.</p>		<p><b>DRAWN:</b> SLM <b>DATE:</b> 11/JUL/08</p> <p><b>CHECKED:</b> SLM <b>DATE:</b> 11/JUL/08</p> <p><b>APPROVED:</b> SLM <b>DATE:</b> 11/JUL/08</p>			
<p><b>TITLE:</b> MEDIUM BACK-UP VENT TOP MOUNT</p>		<p><b>PART &amp; DWG #:</b> PSO-MBUV-T</p> <p><b>MATERIAL:</b> N/A</p>		<p><b>SHEET:</b> 1 OF 1</p> <p><b>SCALE:</b> N/A</p> <p><b>DWG SIZE:</b> A</p> <p><b>FINISH:</b> N/A</p>	
<p><b>PURGE SOLUTIONS</b> WEBSTER, TEXAS, USA 832-398-7199</p>					

**NOTES:**  
 1. REQUIRED HOLE THRU ENCLOSURE  
 WALL FOR VENT IS 2.38Ø (60.5Ø)

SIDE, OUTSIDE WALL OF ENCLOSURE

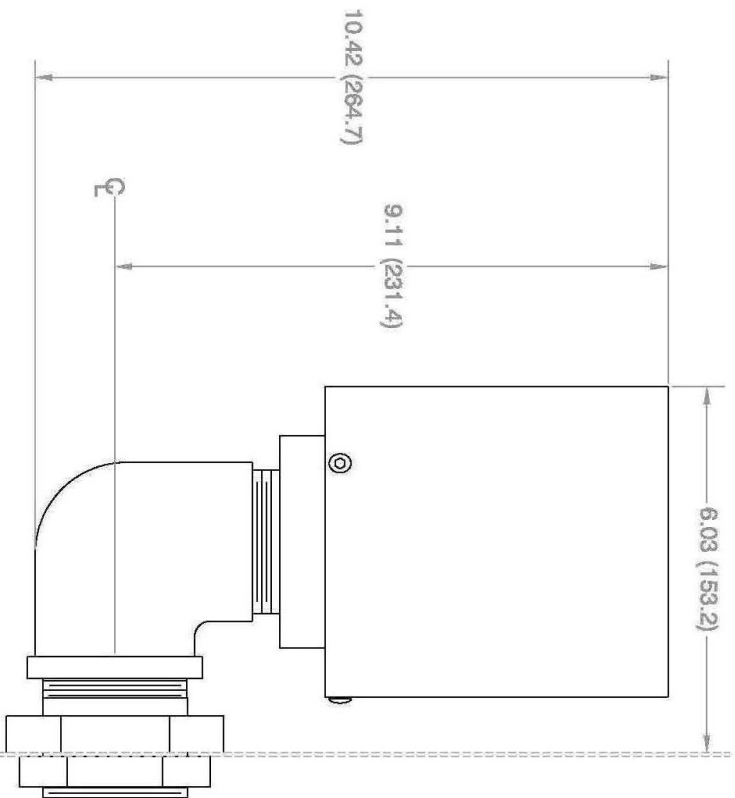

REV #	ECO #	CHANGE(S) DESCRIPTION				DATE	CHANGE BY	APPD BY								
<p>The contents of this drawing is the sole property of Purge Solutions. This print and/or its contents shall not be traced or reproduced without prior written permission from Purge Solutions. It shall not be used directly or indirectly in any way detrimental to the interest of Purge Solutions.</p>		<p><b>DO NOT SCALE DRAWING</b>          UNLESS OTHERWISE SPECIFIED.          Dimensions Are in Inches          Dimensions in O/A in mm          Tolerances: X = ± 0.015          YZ = ± 0.010          ANG = ± 0.005          Break All Sharp Edges          68 Minimum Radii As Noted</p>		<p>DRAWN: <b>WJT</b>          DATE: <b>16/OCT/09</b></p>	<p>CHECKED: <b>WJT</b>          DATE: <b>16/OCT/09</b></p>	<p>APPROVED: <b>WJT</b>          DATE: <b>16/OCT/09</b></p>	<p>TITLE: <b>LARGE BACK-UP VENT          SIDE MOUNT</b></p>	<p>PART &amp; DWG #: <b>PSO-LBUV-S</b></p>	<p>MATERIAL: <b>316 STAINLESS STEEL</b></p>	<p>SHEET <b>1</b> OF <b>1</b></p>	<p>SCALE: <b>N/A</b></p>	<p>DWG SIZE <b>A</b></p>	<p>FINISH: <b>N/A</b></p>	<p><b>PURGE SOLUTIONS</b>          WEBSTER, TEXAS, USA          832-368-7188</p>		



NOTES:  
1. REQUIRED HOLE THRU ENCLOSURE WALL FOR VENT IS 2.38Ø (60.5Ø)

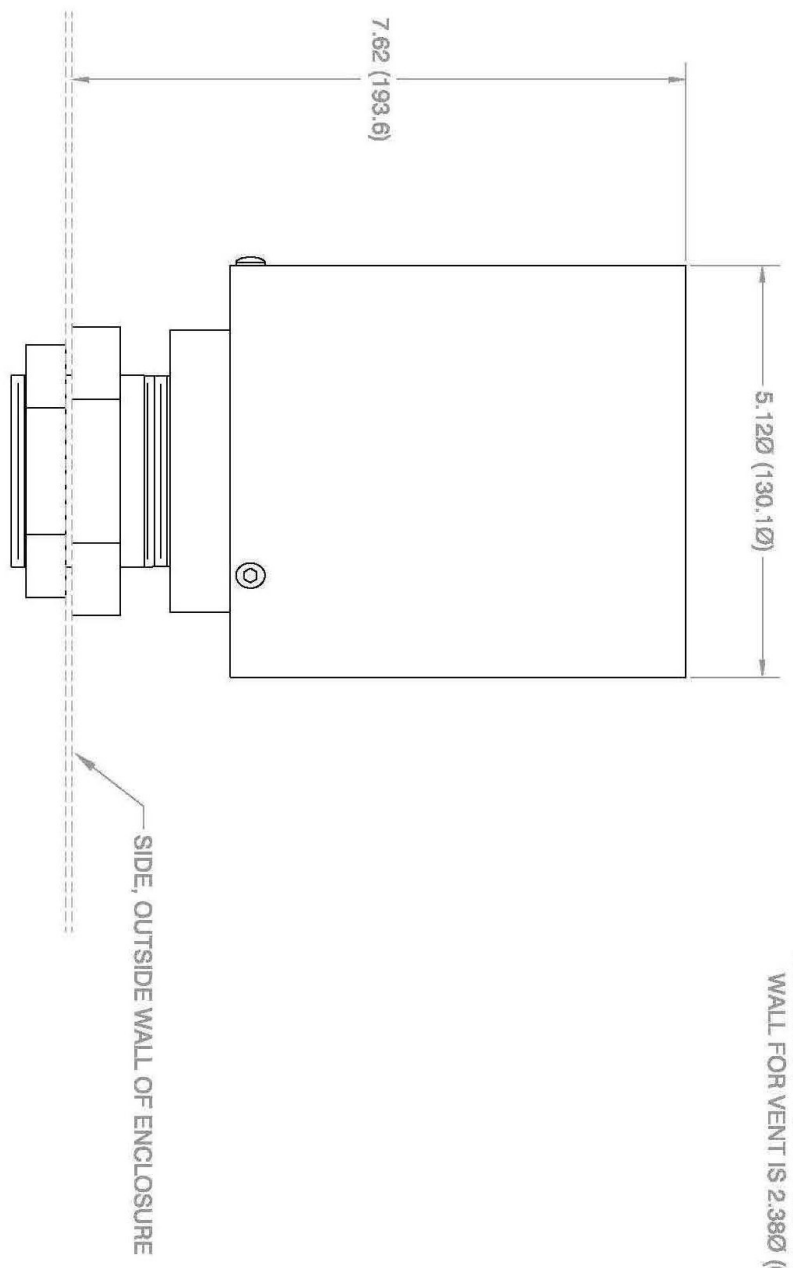

REV #	ECO #	CHANGE(S) DESCRIPTION	DATE	CHANGE BY	APPD BY

<p>The contents of this drawing is the sole property of Purge Solutions. This print and/or its contents shall not be traced or reproduced without prior written permission from Purge Solutions. It shall not be used directly or indirectly in any way detrimental to the interest of Purge Solutions.</p>	<p><b>DO NOT SCALE DRAWING.</b> UNLESS OTHERWISE SPECIFIED. Dimensions are in inches Dimensions in Ø are in mm Tolerances: X = ± 0.015                   XX = ± 0.010                   XXX = ± 0.005 Angular = 0.15° Break All Sharp Edges Ø8 Minimum Except As Noted</p>	<p>DRAWN: <b>WJT</b> DATE: <b>16/OCT/09</b></p>	<p>TITLE: <b>LARGE BACK-UP VENT TOP MOUNT</b></p>	<p>DATE: <b>16/OCT/09</b></p>
		<p>CHECKED: <b>WJT</b> DATE: <b>16/OCT/09</b></p>	<p>PART &amp; DWG #: <b>PSO-LBUV-T</b></p>	<p>MATERIAL: <b>316 STAINLESS STEEL</b></p>
<p>APPROVED: <b>WJT</b> DATE: <b>16/OCT/09</b></p>	<p>SCALE: <b>N/A</b></p>	<p>DWG SIZE: <b>A</b></p>	<p>FINISH: <b>N/A</b></p>	<p>DATE: <b>16/OCT/09</b></p>



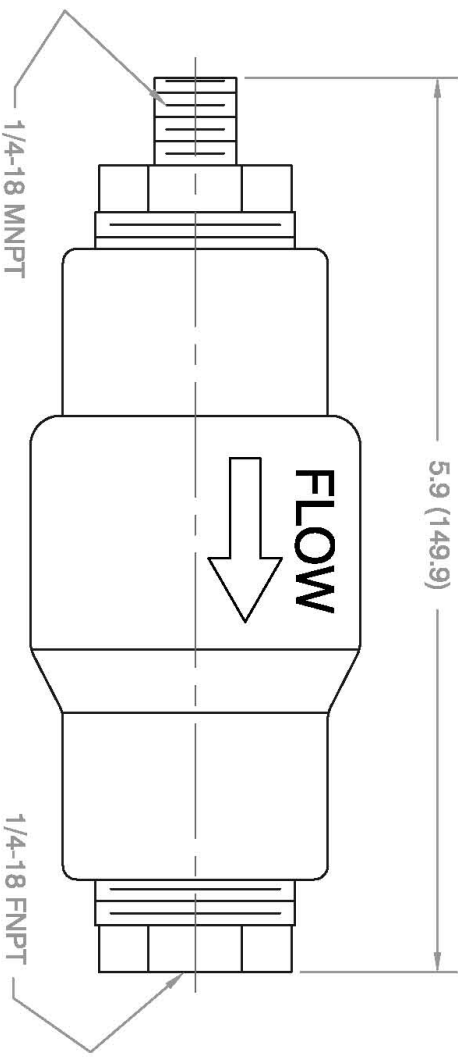
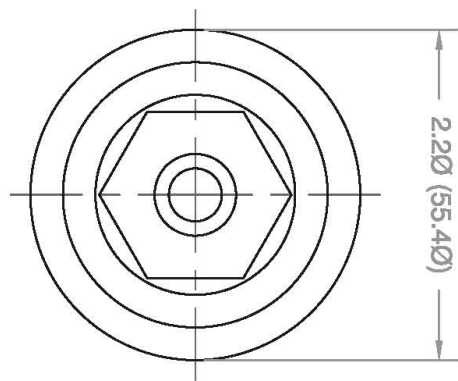

**NOTES:**

1. CRACKING PRESSURE = 0.5 psig (35 mbar).
2. MAXIMUM CONTINUOUS SERVICE TEMPERATURE = 149°F (65°C).
3. MAXIMUM PRESSURE RATING = 100 psig (6.9 bar) @ MAXIMUM CONTINUOUS SERVICE TEMPERATURE.
4. CV = 211 SCFM (5974 liter / M) @ MAXIMUM PRESSURE RATING.

REV #	ECO #	CHANGE(S) DESCRIPTION		DATE	CHANGE BY	APPD BY
<p>The contents of this drawing is the sole property of Purge Solutions. This print and/or its contents shall not be traced or reproduced without prior written permission from Purge Solutions. It shall not be used directly or indirectly in any way detrimental to the interest of Purge Solutions.</p>						
<p><b>DO NOT SCALE DRAWING.</b> UNLESS OTHERWISE SPECIFIED: Dimensions Are in Inches Tolerances: X = ± 0.015                   XX = ± 0.010                   XXX = ± 0.005 Angular = ±0.15° Break All Sharp Edges 69 ✓ Minimum Escape to Head</p>		<p><b>DRAWN:</b> WJT <b>DATE:</b> 18/MAY/11</p> <p><b>CHECKED:</b> WJT <b>DATE:</b> 18/MAY/11</p> <p><b>APPROVED:</b> WJT <b>DATE:</b> 18/MAY/11</p>		<p><b>TITLE:</b> CHECK VALVE VORTEX CABINET COOLER SYSTEM</p> <p><b>PART &amp; DWG #:</b> DO-1145-A</p> <p><b>MATERIAL:</b> PVC, STAINLESS STEEL, EPDM &amp; BRONZE</p> <p><b>FINISH:</b> N/A</p>		
<p><b>SCALE:</b> N/A</p>		<p><b>SHEET:</b> 1 OF 1</p>		<p><b>DWG SIZE:</b> A</p>		
<p><b>PURGE SOLUTIONS</b> WEBSTER, TEXAS, USA 832-388-7186</p>						

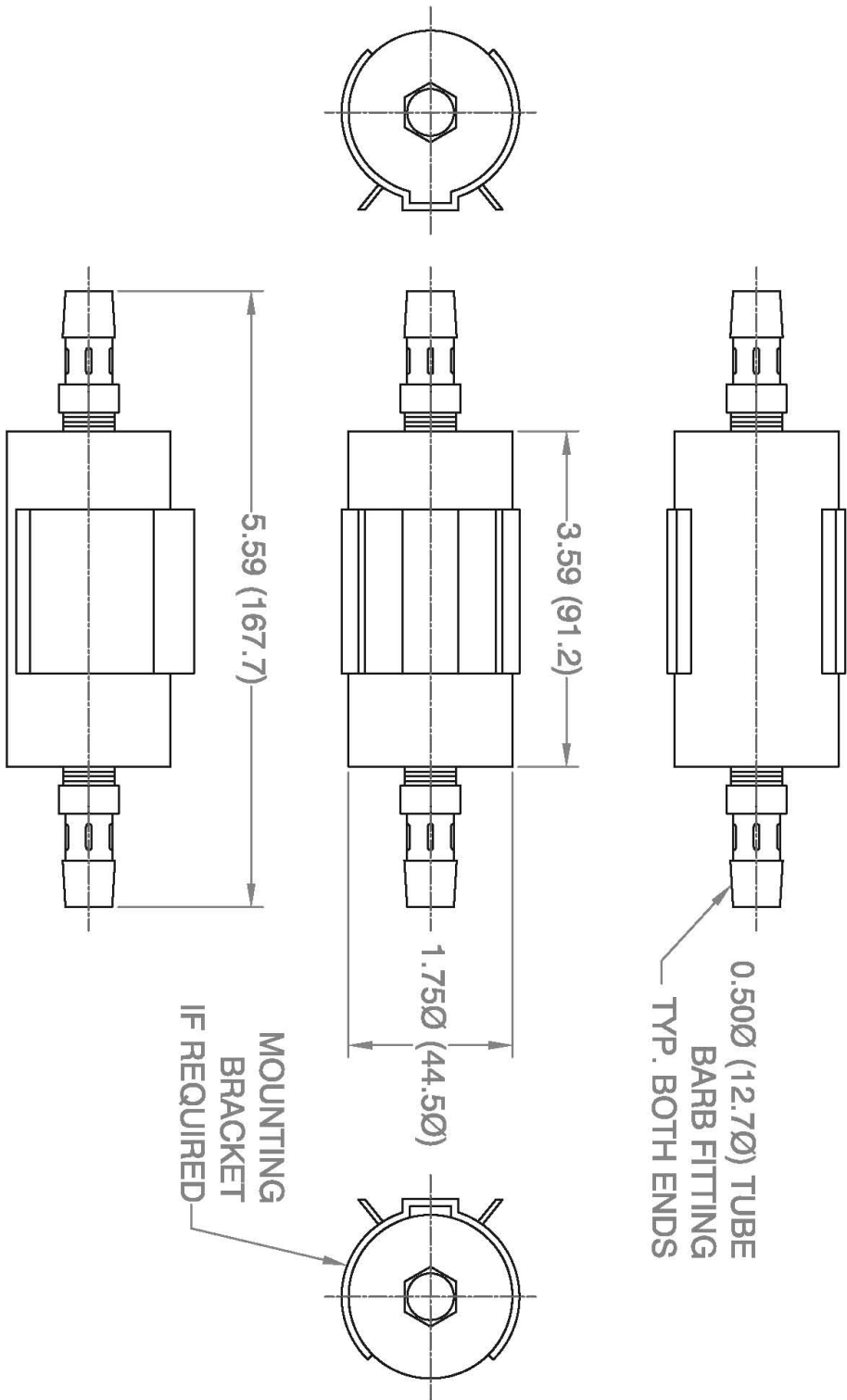

REV #	ECO #	CHANGE(S) DESCRIPTION	DATE	CHANGE BY	APPD BY

The contents of this drawing is the sole property of Purge Solutions. This print and/or its contents shall not be traced or reproduced without prior written permission from Purge Solutions. It shall not be used directly or indirectly in any way detrimental to the interest of Purge Solutions.

**DO NOT SCALE DRAWING.**  
 UNLESS OTHERWISE SPECIFIED:  
 Dimensions Are in Inches  
 Dimensions in ( ) Are in mm  
 Tolerances: X = ± 0.015  
 Y = ± 0.010  
 Z = ± 0.005  
 Angular = ± 0.15°  
 Break All Sharp Edges  
 63 Minimum Edge as Noted

DRAWN: WJT	DATE: 20/JAN/12	CHECKED: WJT	DATE: 20/JAN/12	APPROVED: WJT	DATE: 20/JAN/12
TITLE: COLD AIR MUFFLER		PART & DWG #: DO-11025-A		MATERIAL: NOTED	
VORTEX CABINET COOLER SYSTEM		SHEET 1 OF 1		SCALE: N/A	
FINISH: N/A		DWG SIZE: A		DATE:      CHANGE BY:      APPD BY:	

ALVIN, TEXAS, USA  
 832-388-7189

INSIDE ENCLOSURE CONNECT CHECK VALVE TO OTHER END OF HOSE.  
THIS WILL NOW DELIVER COLD AIR TO ENCLOSURE.

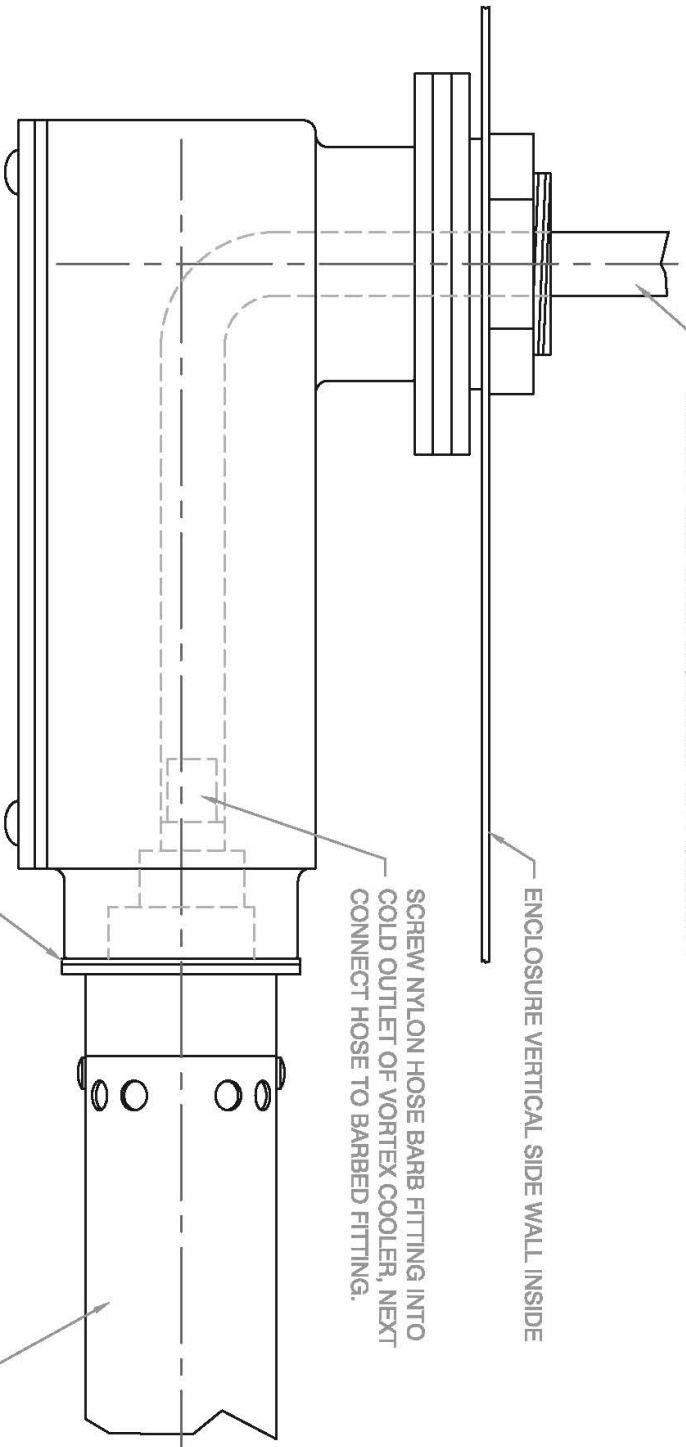

NOTE: CUT A 1 1/2" KNOCKOUT IN ENCLOSURE WALL.

REV #	ECO #	CHANGE(S) DESCRIPTION	DATE	CHANGE BY	APPD BY

<p>The contents of this drawing is the sole property of Purge Solutions. This print and/or its contents shall not be traced or reproduced without prior written permission from Purge Solutions. It shall not be used directly or indirectly in any way detrimental to the interest of Purge Solutions.</p>		<p><b>DO NOT SCALE DRAWING</b> UNLESS OTHERWISE SPECIFIED: Dimensions are in inches Dimensions in ( ) are in mm Tolerances: X = ± 0.015                   XX = ± 0.010                   XXX = ± 0.005 Angular = ± 0.5° Break All Sharp Edges 88 ✓ Aluminum Except As Noted</p>		<p><b>DRAWN:</b> WJT <b>DATE:</b> 29/MAR/10</p>		<p><b>TITLE:</b> <b>SIDE MOUNT DIAGRAM</b> <b>VORTEX COOLER SYSTEMS</b></p>	
<p><b>CHECKED:</b> WJT <b>DATE:</b> 23/MAR/10</p>		<p><b>PART &amp; DWG #:</b> DO-11196-A</p>		<p><b>MATERIAL:</b> NOTED</p>			
<p><b>APPROVED:</b> WJT <b>DATE:</b> 23/MAR/10</p>		<p><b>SHEET:</b> 1 OF 1</p>		<p><b>FINISH:</b> N/A</p>			
<p><b>SCALE:</b> N/A</p>		<p><b>DWG SIZE:</b> A</p>		<p><b>DATE:</b>      <b>CHANGE BY:</b>      <b>APPD BY:</b></p>			

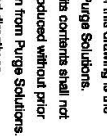

---

## Section 6

# Maintenance & Troubleshooting

### **Maintenance:**

All Vortex Cabinet Cooler Systems have no moving parts. Clean dry compressed air moving through system will not cause wear and should provide service indefinitely. However, if dirt, water or oil enters the Vortex Cabinet Cooler System from the compressed air supply, this can hinder its performance. If this should happen, take Vortex Cabinet Cooler apart for cleaning and reassemble making sure to properly tighten all parts as before.

### **Troubleshooting:**

#### **Insufficient compressed air pressure / flow maybe caused by the following:**

1. Undersized compressed air line size.
2. Compressed air pressure too low; optimal cooling at 100 psig (6.9 bar) compressed air supply pressure to Vortex Cabinet Cooler.
3. Partial or complete blockage of internal compressed air path, due to dirty air supply.

#### **Insufficient cold air temperature maybe caused by the following:**

1. Compressed air line temperature too high.
  2. Water vapor in the compressed air supply, which could also cause ice build-up within the enclosure, leading to water within enclosure.
  3. Loose cold cap. This can occur if not tightened properly after dismantling for cleaning.
  4. Insure that Back-Up Vents are not blocked and exhausting air properly.
-

## Section 7

# Getting Help

Answers to many questions concerning your Increase Safety Enclosure or any of our other products we offer can be found in this manual. If a problem or question is encountered that is not covered in the documentation provided, assistance is available Monday through Friday (except holidays), from 8 a.m. to 5 p.m. United States central time. To obtain assistance, please call Purge Solutions, Inc. at **832-368-7166**.

For assistance during times other than normal business hours, consult our World Wide Web Internet site at **<http://www.purgesolutions.com>**. This site includes equipment information, news releases, and other information. E-mail can be sent to **[info@purgesolutions.com](mailto:info@purgesolutions.com)**.

---

---

### **Purge Solutions, Inc. Standard Terms and Conditions of Sale**

The product, equipment, software, material and / or services (collectively the "Product"), which are described in our quotation, purchase order acknowledgment, packing list and / or invoice hereof shall be sold by Purge Solutions, Inc. only upon the following Standard Terms and Conditions of Sale:

1. **CONTRACT TERMS AND ACCEPTANCE OF PURCHASE ORDER:** These Standard Terms and Conditions of Sale (the "Contract") are the only terms and conditions applicable to the sale of the Products, which are based on qualification and completion of the following: a) Acceptance of any Purchase Order is subject to credit approval by Purge Solutions, Inc. b) Acceptance of completed Purge Solutions, Inc. Customer Information Form. c) Final acceptance of Purchase Order will be Purchase Order Acknowledgment being forwarded to Buyer *(Only until Purchase Order Acknowledgment has been forwarded to Buyer has purchase order been accepted and sent to manufacturing for processing.)*
  2. **QUOTATION PRICES:** Quoted prices are valid for thirty (30) days of quotation date and are exclusive of any applicable taxes, shipping charges and / or any other miscellaneous charges not specified in quote. Prices are subject to change without notice. Any change in quantities, partial release and / or destination may incur a price adjustment.
  3. **PAYMENT TERMS:** Purchase Orders inside the Continental United States; are subject to the approval of Purge Solutions, Inc. Credit Department and unless otherwise agreed in writing, terms of payment are NET thirty (30) days following the date of invoice. Purchase orders outside the continental United States, will be shipped upon receipt of full payment and all costing in US dollars. When the purchase order has been acknowledged, an invoice will be provided. When full payment has been received, including shipping and handling charges, purchase order will be shipped. Purge Solutions, Inc. accepts Visa, MasterCard, Discover and American Express as well as banking transfers. Banking transfer fees are not shared and if banking transfer fees are incorrect; purchase orders will not be shipped. If any Buyer fails to comply with these terms and conditions or sale or if Buyer's credit becomes unsatisfactory to Purge Solutions, Inc., Purge Solutions, Inc. reserves the right to terminate the purchase order without liability to Purge Solutions, Inc. and all future purchase orders of Buyer will be COD or credit card terms before shipping. If a company has an outstanding invoice that is five (5) days past the due date, open purchase orders are subject to being held until such time as the past due status has been brought current.
  4. **DELIVERY DATES:** Quoted delivery dates are approximate estimates determined at the time of quotation and are subject to revisions due to variations in order processing and new purchase orders in manufacturing queue since quoting. Purge Solutions, Inc. assumes no liability for losses arising from inaccurate lead time estimates and is able to make partial shipments against this Contract. The Buyer shall not hold Purge Solutions, Inc. responsible for any delay or damages suffered by the Buyer by reason of any delay due to fires, strikes, riots, Acts of God, priorities, Government orders or restrictions, delays by suppliers or materials or parts, inability to obtain suitable and sufficient labor and / or any other unavoidable contingencies beyond the control of Purge Solutions, Inc. In no case shall Purge Solutions, Inc. be liable for any consequential or special damages arising from any delay in delivery. In the event of such delay, the shipping date shall be extended for a period equal to the time lost by reason of such delay.
  5. **CANCELLATIONS:** Only prior to shipping of Product may Buyer terminate purchase order providing the following: a) Purge Solutions, Inc. is given reasonable notice. b) Purge Solutions, Inc. is compensated for all costs, expenses incurred or committed and for any losses resulting. Once a purchase order has been shipped, all sales are final.
  6. **CLAIMS, DAMAGE OR LOSS IN TRANSIT:** Delivery of Product to carrier from Purge Solutions, Inc. facility or other shipping point shall constitute delivery. Buyer shall bear the risk of loss for damage to or loss of Product from the time Purge Solutions, Inc. delivers Product to carrier, Buyer or Buyer agent. Any claims for damage or loss, which has passed to the Buyer shall be filed with the carrier. Buyer shall give written notice to Purge Solutions, Inc. of any claim for shortage or error in Product shipped within five (5) days of receipt of Product.
  7. **WARRENTY AND LIMITATION OF LIABILITY:** Purge Solutions, Inc. Products are warranted free from defects in material and workmanship at the time of shipment for one year thereafter (One year from date of shipping.). Any claimed defects with Purge Solutions, Inc. Products must be reported within the warranty period and warranty subject to inspection by Purge Solutions, Inc. All warranty inspections are to be performed at Purge Solutions, Inc. facility. Buyer shall ship with shipping charges paid by the Buyer to Purge Solutions, Inc. facility. After inspection by Purge Solutions, Inc. a quotation of proposed work required will be sent to the Buyer. Purge Solutions, Inc. shall be liable only to replace or repair, at its option, free of charge, Products which are found by Purge Solutions, Inc. to be defective in material or workmanship, and which are reported to Purge Solutions, Inc. within the warranty period as provide previously. This right of replacement shall be Buyer's exclusive remedy against Purge Solutions, Inc. Shipment of repaired or replaced products from Purge Solutions, Inc. facility shall be ex-works or FOB Purge Solutions, Inc. facility. Purge Solutions, Inc. shall not be liable for labor charges or other losses or damages of any kind or description, including but not limited to, incidental, special or consequential damages caused by defective Products. This warranty shall be void if product specifications provided by Purge Solutions, Inc. are not followed concerning methods of installation, operation, usage, storage or exposure to harsh conditions (including, but not limited to, temperature and humidity levels outside the approved ranges). Products furnished by Purge Solutions, Inc. by other suppliers shall carry no warranty except that supplier's warranties as to materials and workmanship. Purge Solutions, Inc. disclaims all warranties, expressed or implied, with respect to such Products. The express warranties set forth herein constitute the only warranties with respect to the products sold in connection herewith. Purge Solutions, Inc. makes no representation or warranty of any kind, express or implied (either in fact or by operation of law), with respect to the Products, whether as to their merchantability, fitness for a particular purpose or otherwise. No employee, agent or representative of Purge Solutions, Inc. has any authority to bind Purge Solutions, Inc. to any oral or written representation or warranty concerning the Products over and above that stated herein, except by written amendment signed by Purge Solutions, Inc. and Buyer.
  8. **RETURNS:** Subject to the terms of this Contract regarding CANCELLATION and WARRANTY, All sales are final. Buyer may request a warranty return by contacting Purge Solutions, Inc. and requesting a Return Merchandise Authorization Number. No Product will be accepted for return without a valid Return Merchandise Authorization form and clearly noted on the outside of the shipment. Any return shipment must be made by prepaid freight unless Purge Solutions, Inc. has expressly authorized Buyer in writing to ship such Product to Purge Solutions, Inc. at Purge Solutions, Inc. expense. Any returns of Product authorized by Purge Solutions, Inc. under certain circumstances are subject to a standard restocking charge of 25% of the purchase order's invoice. Non-stock Products are subject to higher restocking charges, if return privileges are extended.
  9. **SERVICES:** Services rendered by Purge Solutions, Inc. whether with or without charge, are only advisory in nature and are only merely incidental to the sales of the Product. When any such services are rendered, Buyer will retain full responsibility for and full control, custody and supervision of the Product, its installation, selection thereof and a representative of Buyer shall be present with full authority to direct operations.
-